

WARNING: DISCONNECT POWER AT THE MAIN FUSE BOX BEFORE INSTALLATION.

WARNING:

This fixture is intended for installation in accordance with the National Electrical Code (NEC) and all local code specifications. If you are not familiar with code requirements, installation by a certified electrician is recommended.

Before assembly, remove all parts and part packages from box. If anything is missing, please contact the retailer from which the product was purchased.

elk HOME

ANY QUESTIONS CALL: 800-613-3261
M-F 8:00AM-6:00PM ET

ITEM#: BV6T5-10-15

1. Hold mounting bracket (A) so tabs on mounting bracket (A) are on the top and bottom and facing out.
2. Place mounting bracket over junction box. Align holes in mounting bracket with holes in junction box. While holding mounting bracket in correct position, mark with a pencil on the wall the location of each hole in each side of mounting bracket. Set bracket aside while installing anchors.
3. Using a drill bit the appropriate size for the included wall anchor (G), drill a hole at each marked location on wall.
4. Using hammer, carefully tap one wall anchor (G) into each hole. Lip of anchor (G) should be flush with wall.
5. Hold mounting bracket (A) so tabs on mounting bracket (A) are on the top and bottom and facing out.
6. Carefully pull house wires out of junction box and pass house wires through large center hole in mounting bracket (A).
7. Align holes in the center of mounting bracket (A) with holes in junction box. Align holes in corners of mounting bracket (A) with wall anchors (G).
8. Thread each junction box screw (B) into holes in center of mounting bracket (A) and into holes in junction box. DO NOT fully tighten.
9. Thread each wall anchor screw (H) into each hole in corners of mounting bracket (A).
10. Fully tighten junction box screws (B) and wall anchor screws (H) to attach mounting bracket (A) to junction box.

CAUTION: Ensure house wires are pulled completely through hole in mounting bracket. **DO NOT** pinch wires between mounting bracket and wall.

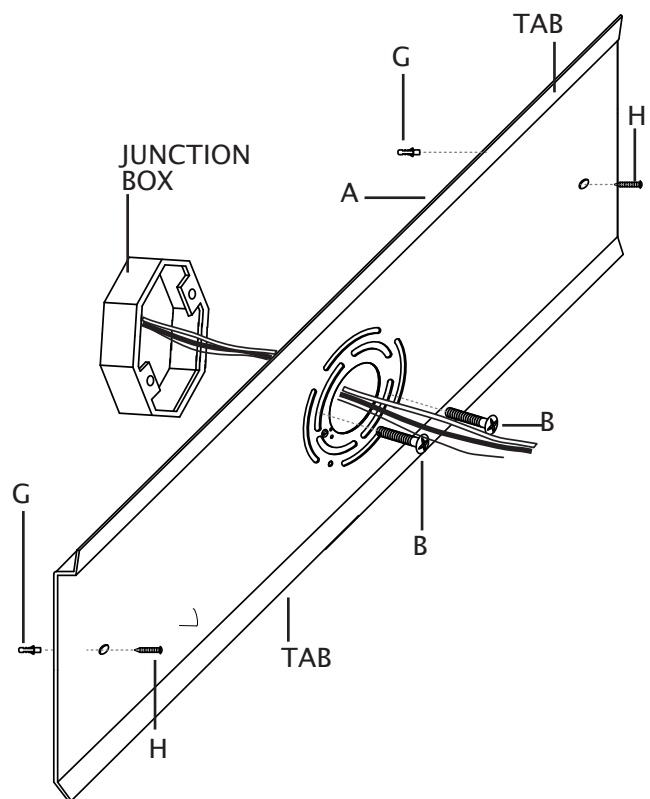

11. Strip 3/4" of insulation from ends of fixture wires.
12. Slightly loosen ground screw on mounting bracket (A). Do not completely remove ground screw. Wrap house ground wire (copper) around ground screw, leaving enough ground wire to attach to fixture ground wire. Twist end of fixture ground wire and end of house ground wire together. Twist wire connector (C) onto ends of wires. Completely tighten wire connector (C). Reference chart below for correct wire connections.

Connect Supply (House) Ground Copper Wire to:
Bare Copper Wire or,
Bare Silver Wire or,
Green Insulated Wire.

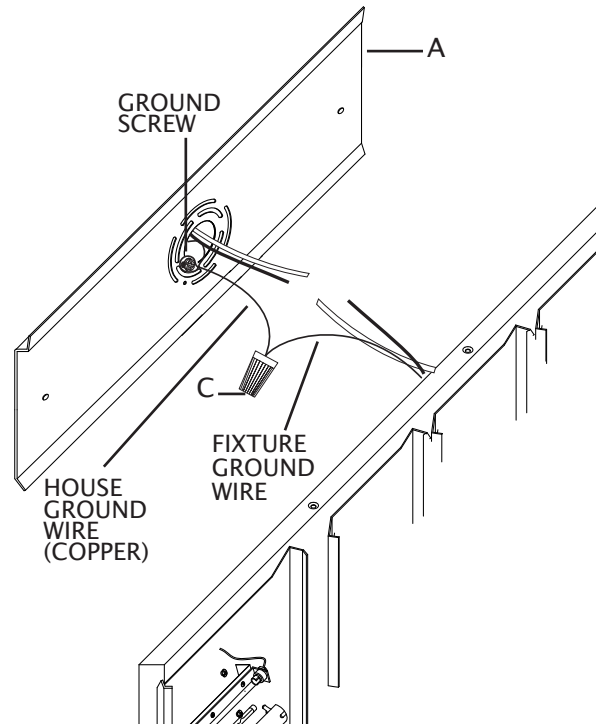

13. Twist end of house lead wire (black) and end of fixture lead wire together. Twist wire connector (C) onto ends of wires. Completely tighten wire connector (C). Twist end of house neutral wire (white) and end of fixture neutral wire together. Twist wire connector (C) onto ends of wires. Completely tighten wire connector (C). Reference chart to the right for correct wire connections.
14. Wrap electrical tape (not included) around wire connectors (C) and wires. Ensure wires are securely fastened into wire connectors.
15. Carefully push all wires and wire connectors into junction box.

Connect Black Lead Supply (House) Wire to:	Connect White Neutral Supply (House) Wire to:
Black Wire or,	White Wire or,
*Parallel Cord (Round and Smooth) or,	*Parallel Cord (Square and Ridged) or,
No printed words on wire insulation or,	Printed words on wire insulation or,
Insulated Wire (other than green) with Copper Conductor.	Insulated Wire (other than green) with Silver Conductor.
*When parallel wire (SPT 1 & SPT 2) is used: The lead wire is round in shape or smooth. The neutral wire is square in shape or ridged.	

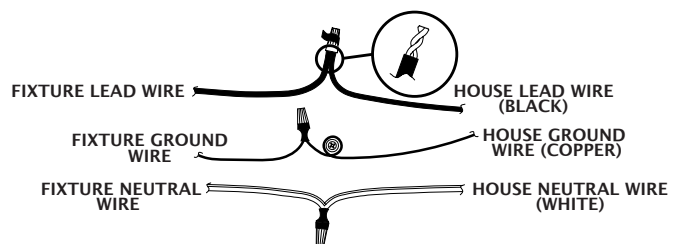

16. Place backplate (D) over mounting bracket (A).
CAUTION: Do not pinch wires between backplate and wall.
17. Align holes in top and bottom of backplate (D) with holes in tabs on mounting bracket (A).
Thread one fixture mounting screw (E) into each hole in top and bottom of backplate (D) and into holes in tabs on mounting bracket (A). Tighten fixture mounting screws (E) to secure fixture to wall.
18. **CAUTION:** DO NOT touch bulb with bare hands. Oils from skin can damage bulb. Carefully insert bulb (included) into socket. Each end of socket is spring-loaded. Carefully push bulb towards the end you just inserted and fit other end of bulb into other end of socket. **WARNING:** DO NOT exceed maximum bulb wattage.
19. Install bulb cover (L) over each bulb.
20. From top of fixture, carefully lower one glass panel (K) down over each bulb. Fit sides of glass panel behind tabs on backplate (D).

